

# Intake Housing and Components Route Map and Summary

Gas Turbine Air Treatment Decision Guide

# Intake options

- Weather protection
- Moisture protection including coalescing filters
- Sequence of filters and arrangement
- Laminar air flow to compressor
- Instrumentation and controls

# Filter house design to reduce moisture (Nederman)

## Addressing Moisture Issues

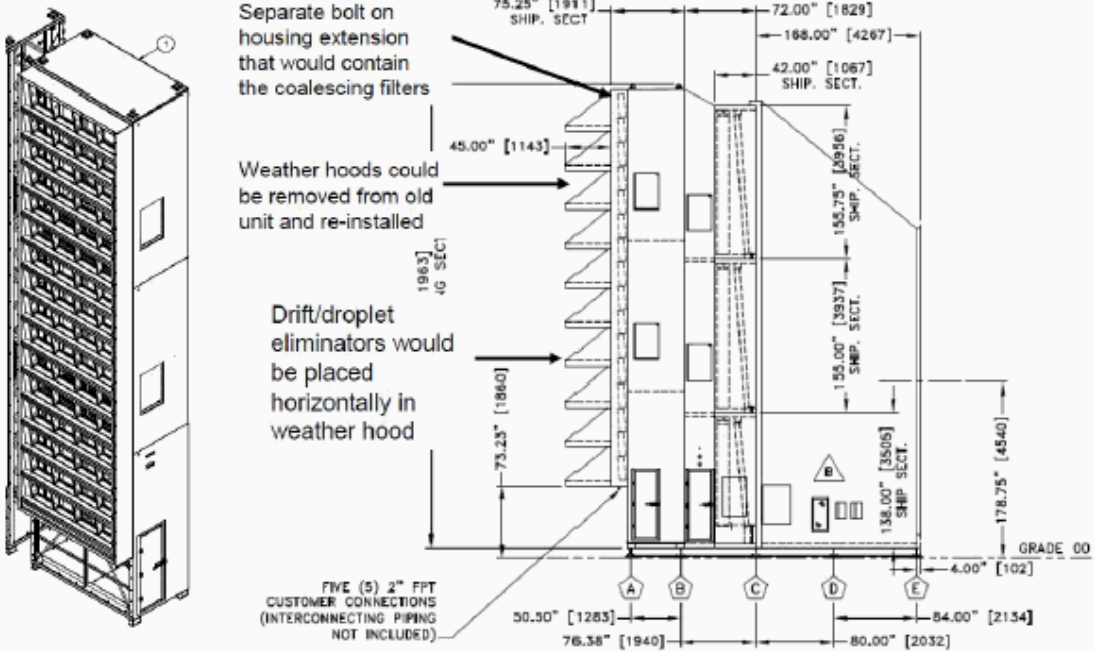

# Filter House Modifications and Upgrades

Typical Aftermarket Needs:

- Customer needs additional unit output
- Change in Operating Conditions
- Change in Surrounding Environment
- Retrofit of existing filter house to add power augmentation (i.e. evaporative cooler, chiller, fogging, etc.)
- Retrofit of existing house to upgrade or change filtration configuration.
- Retrofit for the addition of moisture removal.
- Retrofit to reduce pressure drop.



Evaporative Cooler

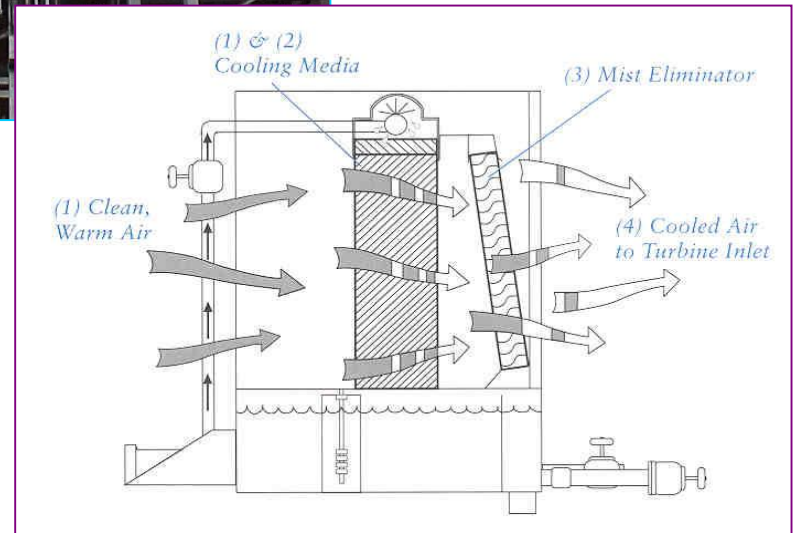

# Filter House Modifications and Upgrades

IPS knows first hand how important it is to have an inlet system functioning at peak performance. Our years of experience combined with our commitment to keeping up with current industry trends and technological advancements means you can trust our judgment. We are committed to providing an extensive evaluation of your unique gas turbine inlet system, and offering critical and insightful approaches to improvement. Our team will design a proposal specifically for your gt inlet system needs and expertly manage all the details of repair or replacement, ensuring minimum downtime and maximum return.

IPS can provide complete system upgrades or custom solutions to your existing unit.



IPS Contact

David Clarida

[david.clarida@ipsok.com](mailto:david.clarida@ipsok.com)

O: 918.925.9693

C: 918.549.0009

# DRB's Services



- Gas Turbine Filter Installation / Change-out
- Evaporative Cooling Media Installation / Change-out
- Fog Cooling Installation
- Inlet & Exhaust Silencers
- Plenum Repair & Upgrades
- Expansion Joint Repair & Replacement
- Filter House Design, Fabrication, & Installation
- Filter House Frames & Modifications
- Evaporative Cooling Modules, Design, Fabrication, & Installation
- Enclosures
- HRSG Boiler Repair & Stack Dampers
- HRSG Repair
- Liner Repair & Replacement
- Gas Turbine Filter House Inspection
- Evaporative Cooling Inspection
- Consulting & Testing Services
- Training & Seminars – Inlet Filtration, Inlet Cooling, & Silencers



[sales@drbindustries.com](mailto:sales@drbindustries.com)

[www.drbindustries.com](http://www.drbindustries.com)

918-286-7176 - phone

# Clarcor provides full intake packages



## CLARCOR Gas Turbine filtration

CLARCOR Industrial Air have been providing Gas Turbine air intake solutions since 1966 (Altair business) to all GT OEMs. In 2006, purchased by GE, innovation and R&D was further aligned to Gas Turbine performance. Today an independent supplier, these designs can be utilised on all Gas Turbines.

CLARCOR offers;

- Product Innovation driven by Gas Turbine Compressor and Turbine health (PRO technology).
- Extensive experience and portfolio of Pulse, Static & Hybrid filter house solutions on GTs ranging from 2 to 250MW+.
- Moisture, salt removal and power augmentation (cooling) systems, land-based and offshore.
- Full filter portfolio from G1 - H13 (HEPA) for power generation and mechanical drive applications.
- Flexible approach to supply chain, willing to supply full intake package or individual components.

Through GT OEM ownership, Intake systems designed to enhance GT performance

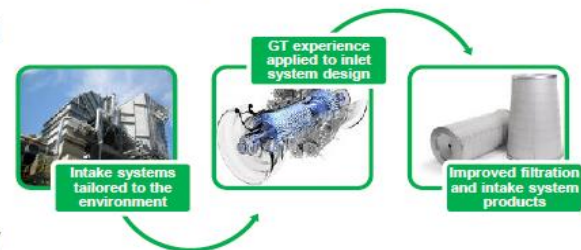

Complete range of GT filter product types of all grades up to HEPA



# ATCO Inlet Anti-Icing Systems

- The blower forces ambient air into offset arrays of circular tubes just inside the exhaust duct shell.
- Air flows through the heat exchanger counter to the exhaust gas path, warming as it travels.
- The heated air is then transported through ducting to distribution rakes at the filter house inlet, where it flows evenly across its face.
- The warm air is introduced upstream from the first stage of the inlet filter, raising the overall temperature of combustion airflow to shift air conditions out of the icing risk range.
- Quiet operation with no environmental impact (no glycol disposal)
- Protection of vital turbine components
- Utilization of waste heat from exhaust
- Virtually zero system pressure drop
- Guaranteed minimum 10°F temperature rise at gas turbine mouth (higher temperature rise is easily achieved)
- Minimal maintenance
- Adaptability to any gas turbine model
- Low noise option
- Competitive cost
- Minimal parasitic load
- Protection of filter elements against frost or ice



# Layers of expertise in filter cleaning

How should it be configured?

How will it perform?

Why does it perform?

How to innovate?

## 1 Cleaning Calculation System



### Filter Cleaning System Configuration

Instant configuration and assessment of filter cleaning performance for bag filters and cartridge filter applications.

## 2 Laboratory & Application testing

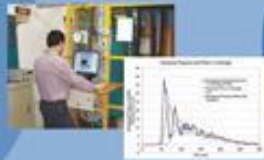

Assessment of filter cleaning system performance in application or in the laboratory using actual system hardware, under actual operating parameters. Detailed reverse pulse profiles, filter overpressures, orifice size distributions and outflow angles.

## 3 Numerical Modelling

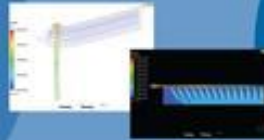

Advanced simulation of filter cleaning systems and component performance using computational fluid dynamics and mathematical modelling.

## 4 Customer Innovation



Innovative system and component design solutions in partnership with customers.

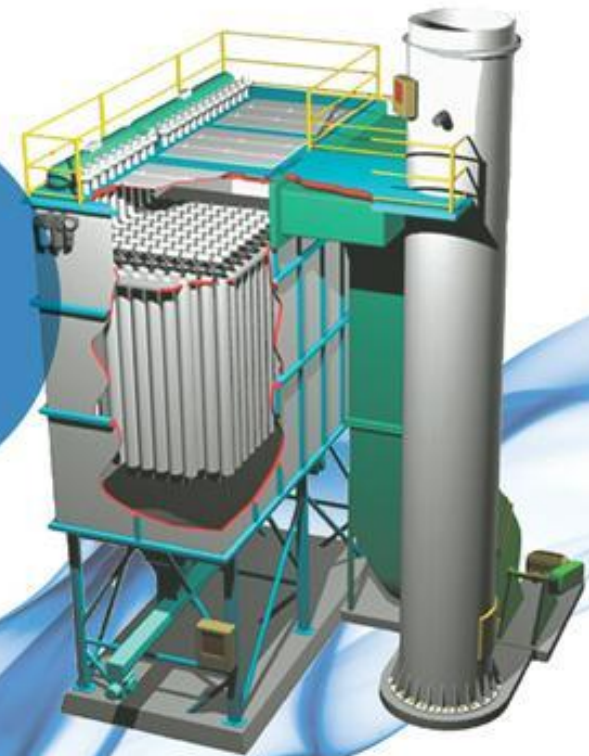

**Pentair Clean Air Systems supports customers in all industries with technical solutions for filter cleaning problems from design to application.**

# Pentair Clean Air Systems: Goyen and Mecair



Diaphragm valves  
Solenoids



Pressure & leak testing



Stainless steel pilot  
tubing

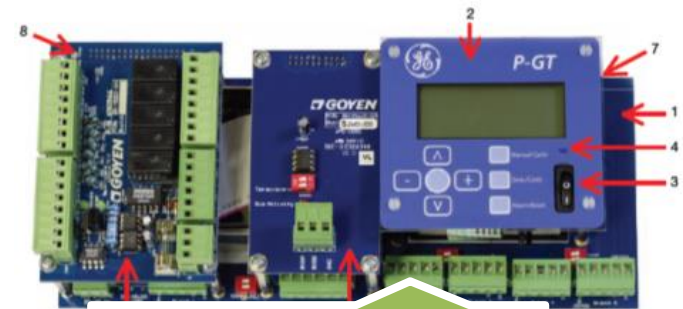

Gas Turbine Pulse  
System Controller  
P-GT



**BRADEN  
MANUFACTURING, LLC**

® A Global Power Company

# COMPUTATIONAL FLUID DYNAMICS (CFD)

## Intake Filtration System Velocity Streamline Profile Simple Cycle Exhaust System Gas Velocity Streamline Profile

Filter House; Velocity Streamlines in Fluid Domain

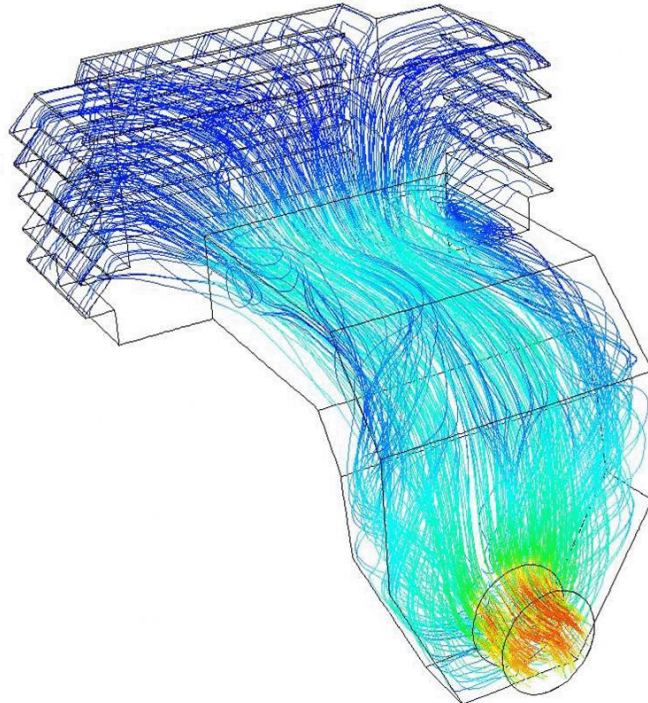

7EA EXHAUST WITH CO MODULE  
VELOCITY STREAMLINE PLOT

Velocity  
(Streamline 1)

48.8
43.4
38.0
32.6
27.2
21.7
16.3
10.9
5.5
0.0

[m s<sup>-1</sup>]

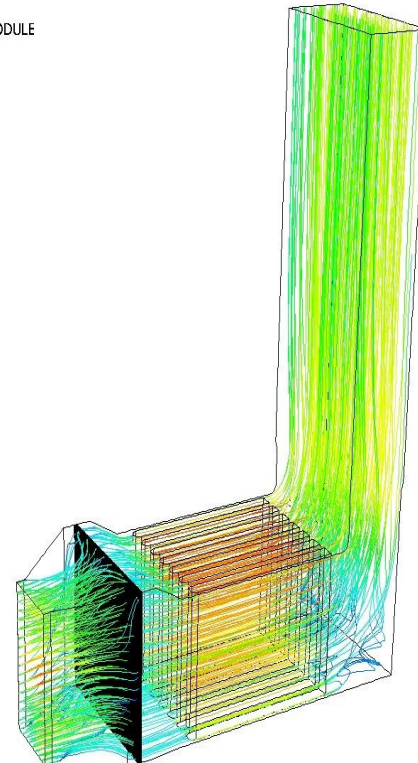



# **BRADEN MANUFACTURING, LLC**

® A Global Power Company

## *BRADEN PRODUCTS*

- **Air Filter Inlet Systems:**
- Multi Stage Barrier and Pulse Filtration Systems
- Anti-Icing Systems
- Intake Cooling Systems
- Evaporative Coolers
- Chiller Coils
- **Inlet Systems, including:**
- Unlined Inlet Ducts
- Externally Lined Ducts
- Internally Lined Ducts
- Silencers
- Inlet Plenums
- Expansion Joints and Flex Seal upgrades

# New Products Recently Introduced

- TriCel™ Static V-Bank E Class Filtration
  - We offer both 12" - 17" deep v-bank TriCel
  
- ExCel™ Premier Web ( EPW )
  - *F9 Synthetic Pulsed GT Inlet Filters*
  - *MERV 15 to effectively filter submicron dust*
  - *80% new filter efficiency on 0.30 µm particles*
  - *0.78" W.G. at 1500 cfm*

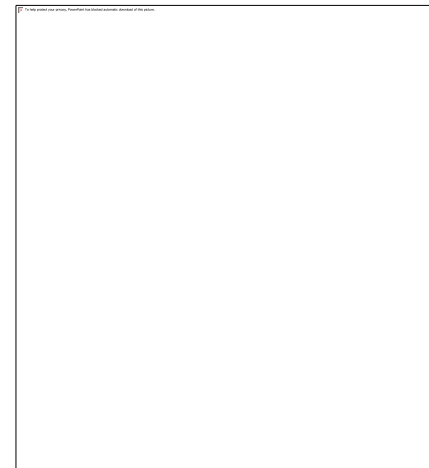
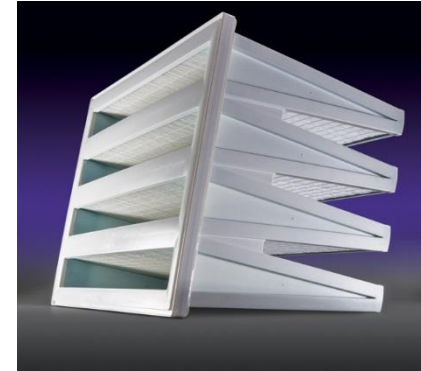



# BRADEN MANUFACTURING, LLC

® A Global Power Company



Inlet Chiller Coils by Braden